

TOILET BRUSH SET AC261



97 x 391 x 129 mm

- Toilet brush set in solid, germ-reducing and easy-care stainless steel (AISI 303), satin finished.
Further available surfaces: see below.
- Concealed anti-theft two-point rosette wall mounting.
- Brush head replaceable.
- Cup removable. Internal stop bolt for optimum brush-position.
- Holder diameter 16 mm
Cup inner diameter 84 mm
Cup height 130 mm
- Mounting with two screws.
- Delivery includes fixing material.
- Weight, including single package: 1.3 kg



Suggested text for specifications:

Toilet brush set in solid stainless steel (AISI 303), satin finished, for surface mounting. Concealed anti-theft two-point rosette wall mounting. Brush head replaceable, cup removable with internal stop bolt for optimum brush-position. Delivery includes fixing material.

Dimensions: 97 x 391 x 129 mm

Article No. AC261

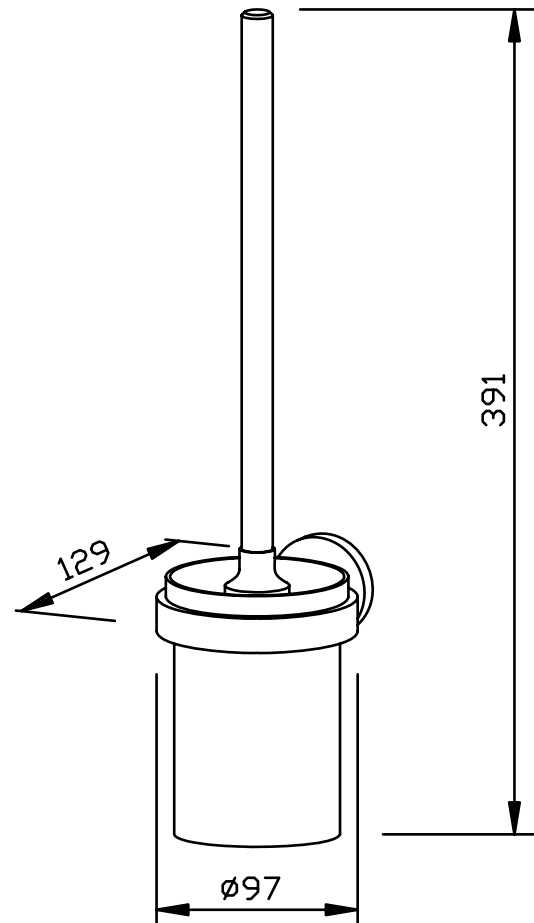

Available surfaces	ID No.
satin finished (standard)	700 261
highly polished	731 261

Ernst Wagner GmbH & Co. KG

Ernst-Abbe-Straße 21 · D-72770 Reutlingen · Tel.: +49712151539-0 · Fax: -20
info@wagner-ewar.de · www.wagner-ewar.de

WAGNER
EWAR